

# HEL SINKI 90 ISLAND, X7H09S.

## Specifications

<b>Model No.</b>	X7H09S
<b>Hood Mounting</b>	Island Mount Canopy
<b>Dimensions</b>	<b>Hood Width</b> 900mm
	<b>Hood Depth</b> 362mm
	<b>Hood Height</b> 800mm*

\* Custom Height Available - X1FZ.010

<b>Cooking Surface Coverage (cm)</b>	75-100cm
<b>Min Install Height</b>	600mm
<b>Recommended Install Height</b>	700-750mm

<b>Induction Suitable</b>	●
<b>Char Grill Suitable</b>	-

<b>Finish</b>	<b>AISI304 1.2mm Food Grade</b>	●
	<b>AISI316 1.2mm Marine Grade</b>	-

<b>Filtration</b>	<b>Type: S-Flow Baffle</b>	●
	<b>Filter Quantity</b>	3

<b>Electronics</b>	<b>MasterMind</b>	●
	<b>Controls</b>	4-Button Backlit LED MasterMind Electronic Control
	<b>Wireless Remote</b>	○
	<b>Speed Settings</b>	3 Speed + Boost Mode
	<b>Timer Function</b>	Programmable Timer 10min Increments
	<b>Auto Fan Shut Off</b>	Auto Off After 2-Hours Of Inactivity

<b>Lighting</b>	<b>Type: LED - Warm White</b>	●
	<b>Type: LED - Cool White</b>	○
	<b>Lamp Quantity</b>	5
	<b>Front Panel</b>	●
	<b>Rear Panel</b>	●

<b>Exhaust</b>	<b>Outlet Position - Top</b>	●
	<b>Outlet Position - Rear</b>	-
	<b>Outlet Quantity</b>	1
	<b>Ducting (Remote Motor)</b>	Zilikon Duct - Dia. 200mm 5M Length Supplied
	<b>Ducting (Onboard Motor)</b>	Power Motor - Dia. 150mm Ultra Motor - Dia.200mm Not Supplied - Duct Kits Available

SELECT YOUR HOOD & MOTOR COMBINATION X7H09S5 / X7H09S6

<b>On Board</b>	<b>Power 1020 - Top</b>	1020m³/hr	.OP/T
	<b>Ultra 1680 - Top</b>	1680m³/hr	.OU/T
<b>Inline</b>	<b>Lite 800</b>	800m³/hr	.IL
	<b>Pro 1140</b>	1140m³/hr	.IP
<b>External</b>	<b>Lite 800</b>	800m³/hr	.EL
	<b>Pro 1140</b>	1140m³/hr	.EP
	<b>Pro Plus 2010</b>	2010m³/hr	.EPP

● Standard Inclusion ○ Optional - Not Available

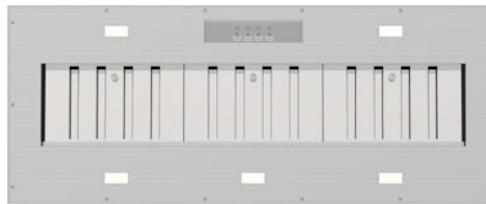
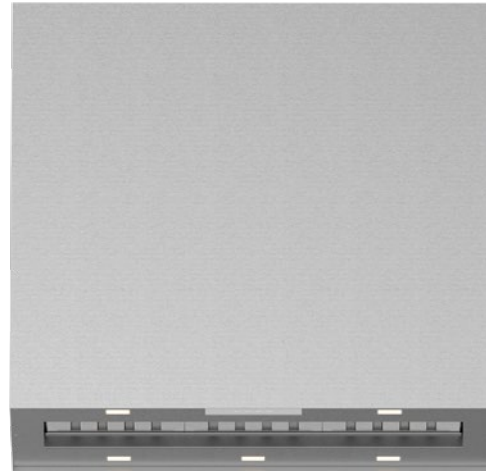

Filtration Zone.

**Your Hood. Your Colour. Your Way.** Select your hood finish.

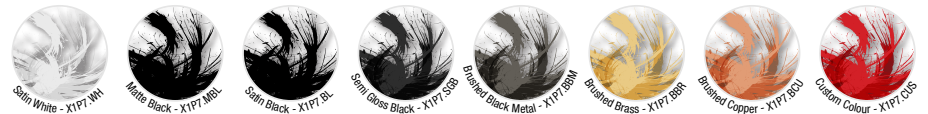

## Dimensioned Drawing

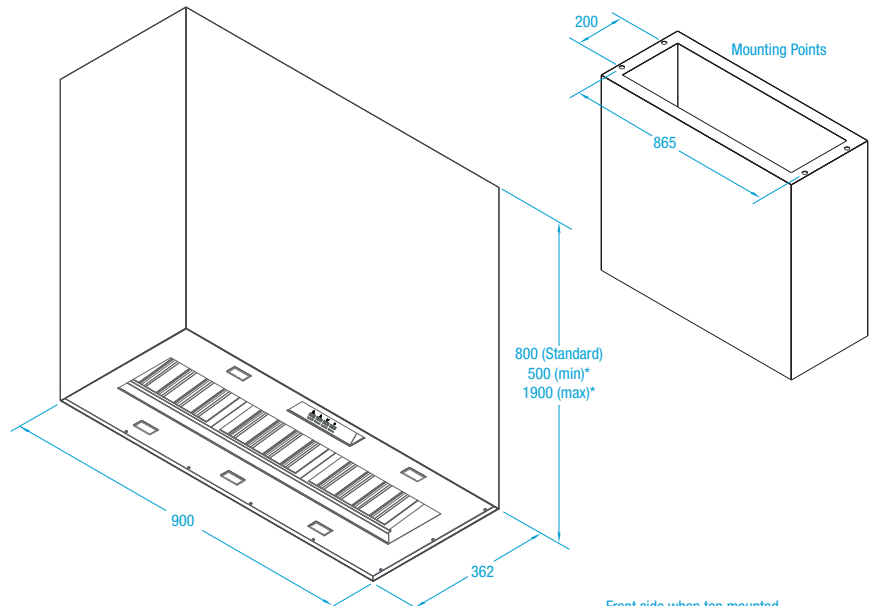

800 (Standard)  
500 (min)\*  
1900 (max)\*

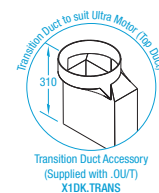

Transition Duct Accessory (Supplied with .OU/T) X1DK.TRANS

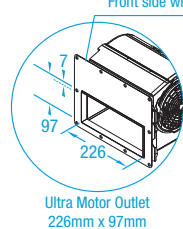

Ultra Motor Outlet 226mm x 97mm

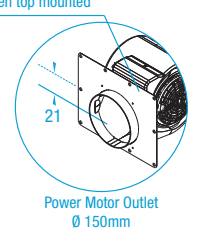

Power Motor Outlet Ø 150mm



5 YEAR WARRANTY  
COMPREHENSIVE PARTS & LABOUR



10 YEAR WARRANTY  
REPLACEMENT PARTS AND MOTOR



LIFETIME  
REPLACEMENT PARTS WARRANTY



PROUDLY AUSTRALIAN OWNED  
DESIGNED & BUILT IN MELBOURNE



PREMIUM GERMAN MADE  
MOTOR SYSTEMS

# whispair